















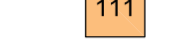







**LEGGENDA**

-  SEDE STRADALE
-  ITINERARIO CICLOPEDONALE
-  TRATTO PRECLUSO AL TRANSITO
-  AREA SORMONTABILE
-  VERDE
-  CADITOIA DI RACCOLTA PER ACQUE METEORICHE ESISTENTE
-  CADITOIA DI RACCOLTA PER ACQUE METEORICHE
-  CAMERETTA DI ISPEZIONE ESISTENTE
-  CAMERETTA DI ISPEZIONE PER ACQUE METEORICHE DIMENSIONI INTERNE: 150 x 150 cm
-  ALLACCIAMENTO DELLE CADITOIE Ø 160 mm in PVC - J min. 0.5 %
-  COLLETTORE PER ACQUE METEORICHE Ø600 mm in CLS
-  COLLETTORE PER ACQUE METEORICHE Ø500 mm in CLS
-  COLLETTORE PER ACQUE METEORICHE Ø400 mm in CLS
-  COLLETTORE PER ACQUE METEORICHE Ø315 mm in PVC
-  COLLETTORE IN PRESSIONE Ø 90 mm in PeAD
-  COLLETTORE Ø 1000 mm ESISTENTE
-  DIREZIONE DEL COLLETTORE DI FOGNATURA
-  BABEL OF AS-4W 4.7-9 BABEL OF AS-4W 4.7-9 76 W
-  VASCA VOLANO
-  STAZIONE DI SOLLEVAMENTO

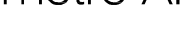
-  Perimetro ARU-05
-  Limite di proprietà ridisegnato con P.A. rif. tav. n. t.16
-  Parcheggi di futura realizzazione

Progettisti

**OFFICINA PROGETTAZIONE ARCHITETTURA URBANISTICA DESIGN**

ARCHITETTO ORIANO FABRIZIO DURANTE  
ARCHITETTO ERSILIA DEL GENIO

**STUDIO ASSOCIATI REDAELLI**

I 20871 VIMERCATE - MB  
VIATERRAGGIO DELLA PACE 4  
TEL. +39 039 6084242  
FAX +39 039 6084222  
PARTITA IVA 03115000964  
studio@redaelliassociati.it

Comune di BRUGHERIO (MB)

**Piano Attuativo**

Area dismessa AlfaGomma SpA - ARU 05  
Viale della Vittoria - Viale Lombardia

La proprietà

**ALFAGOMMA REAL ESTATE S.P.A.**

Via Tori Bianche n.1  
20871 Vimercate (MB)

OPERE DI URBANIZZAZIONE  
Nuova viabilità

Scala 1 : 200

Maggio 2017 - integrazioni Febbraio 2018

I progettisti

Tavola

**t.17**

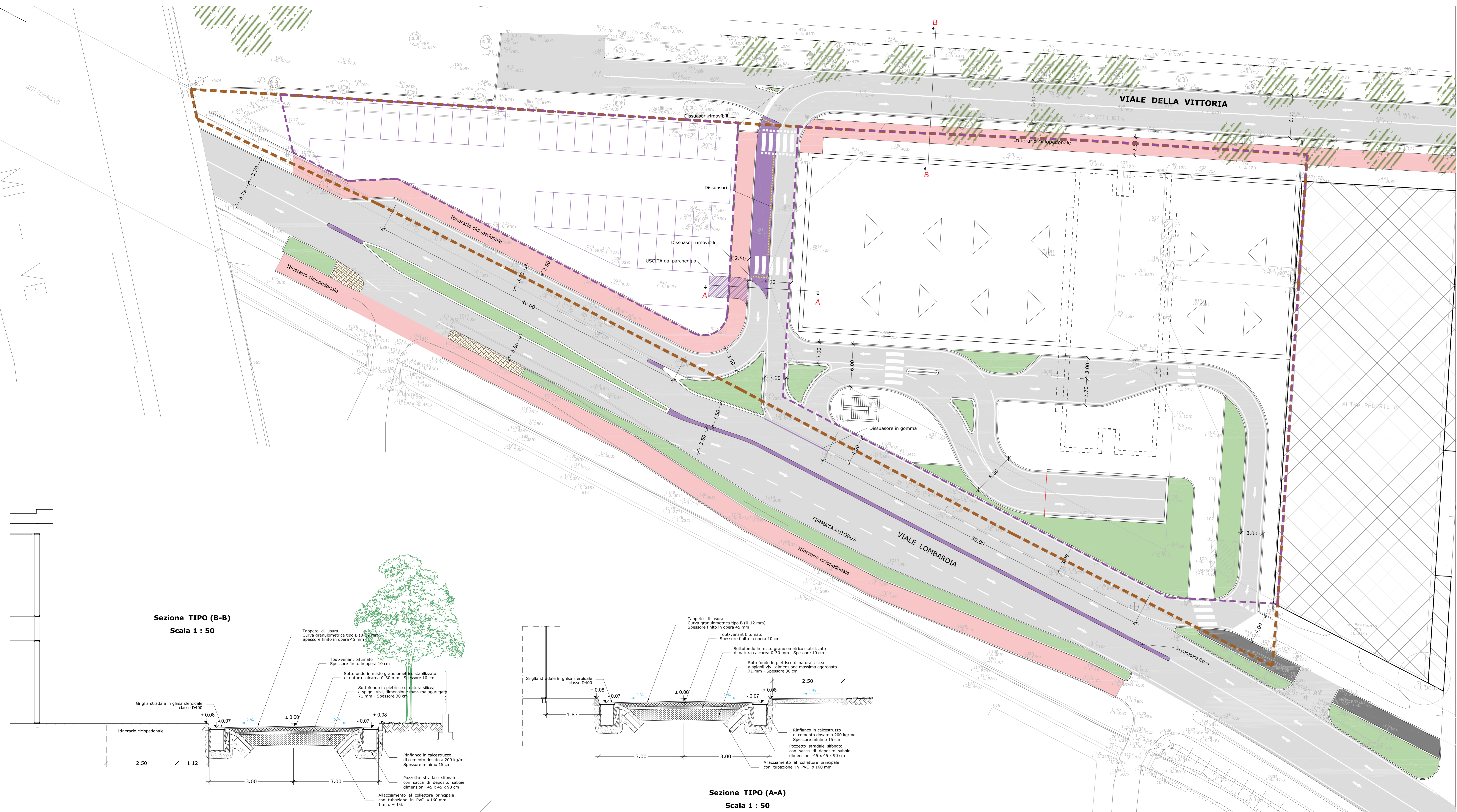

**Sezione TIPO (B-B)**  
Scala 1 : 50

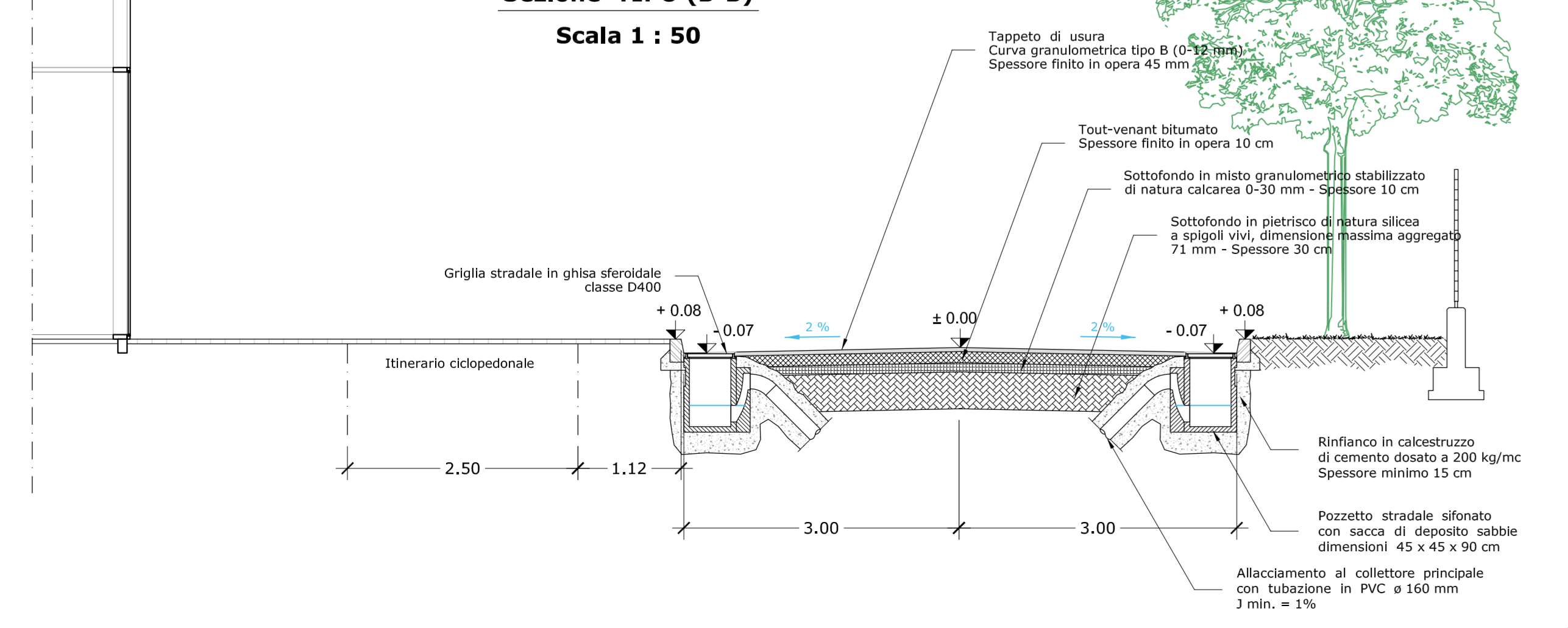

**Sezione TIPO (A-A)**  
Scala 1 : 50

